

SUPREME

WOODBURNING FIREPLACES



OPUS

OPUS



Supreme is proud to introduce the Opus, the first and only EPA approved non-catalytic see-through fireplace. With its appealing and modern design, the Opus is ideal for any open concept home. Both doors are functional, offering a very large and high viewing area. This exclusive fireplace comes completely assembled with a patented automatic air control, giving customers a user-friendly fireplace that they will enjoy for a lifetime.

SUPREME
A warm touch to your home



The OPUS won a Vesta Award for best new wood burning fireplace. The Vesta Awards are presented by Hearth & Home Magazine, at an industry-wide ceremony, honouring companies for their innovations in product design and technology.

FEATURES

- Stainless steel combustion chamber
- No refractory bricks, allowing a quicker and better heat transfer
- Combustion is controlled by a patented automatic air control
- Compact size
- Very large and high viewing area
- Comes completely assembled
- Unique chimney sweeping cap
- Both doors are functional
- Integrated ash pan
- Fireplace available in black or charcoal
- Tested and approved with a 6 inch chimney
- Can be installed inside a masonry chimney with a stainless steel liner
- 25 year limited lifetime warranty

OPTIONS

- Moldings come in antique brass and brushed nickel
- Doors available in gold and brushed nickel
- Decorative corners, in sets of two, come in black, antique brass or charcoal
- Hot Air Duct Kit

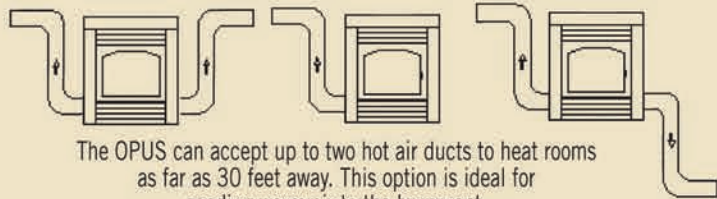

The Opus can be installed with the following chimneys:

- Super Pro (model SPR or ALT), 6"
- Supervent (model JSC or JM), 6"
- Selkirk (model Ultra Temp or CF Sentinel), 6"
- Security Chimneys (model Secure Temp ASHT or S-2100), 6"
- Oliver MacLeod (model HT 6000), 6"
- ICC (model Excel 2100-2), 6"
- Simpson Dura-Vent (model Duratech HT or Duraplus HTC), 6"
- Metal Fab (model Temp Gard, class A), 6"
- American Metal (model Ameritex HS or HSS), 6"

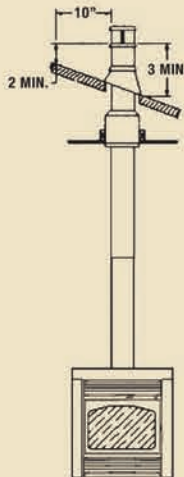

SPECIFICATIONS

Heat Output:	75,000 BTU (estimated)
Heating Capacity:	1,500 square feet
Size of Firebox:	2.8 cubic feet
Weight:	230 pounds
Tested & Approved :	EPA, UL 127-1999, ULC-S610-M87 R-94
Emissions:	5 g/hr
Burn Rate:	0.83 kg/hr
Log Size:	21 inches (maximum)

Patent No: US 7,325,541 B2

DIMENSIONS

Minimum Framing Dimensions

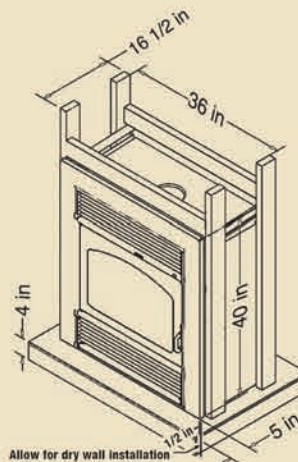
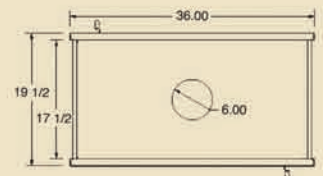

CANADA INSTALLATION
NOTE: Podium minimum height 4 in
Podium maximum width 5 in

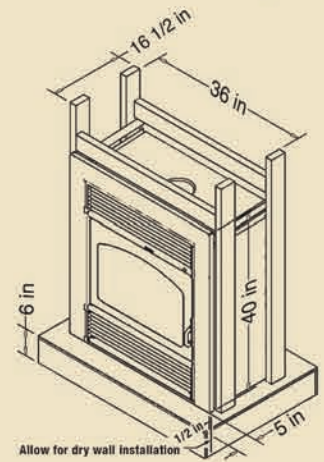

US INSTALLATION
NOTE: Podium minimum height 6 in
Podium maximum width 5 in

TYPES OF INSTALLATIONS

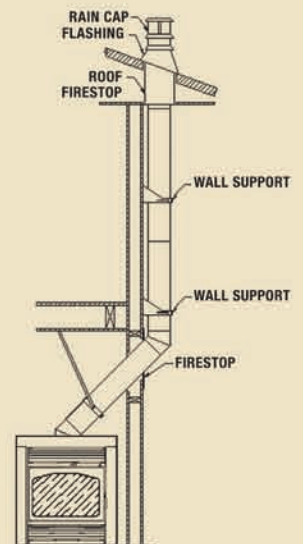
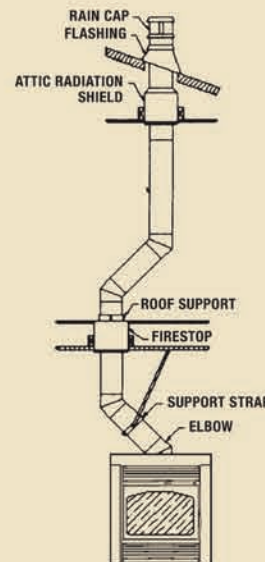

SUPREME
WOODBURNING FIREPLACES

A warm touch to your home

Designed & Manufactured by SUPREME
3594 Jarry East, Montreal (Quebec) Canada H1Z 2G4
info@supremem.com
www.supremem.com

Your dealer